

45823

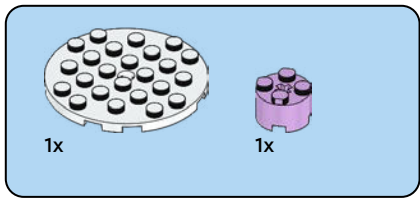

1

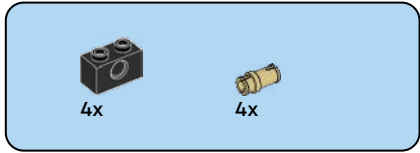
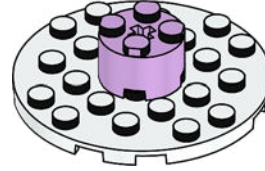

2

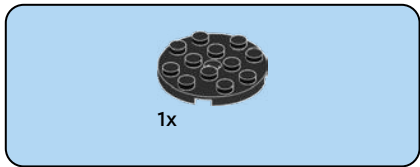
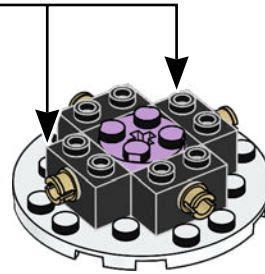
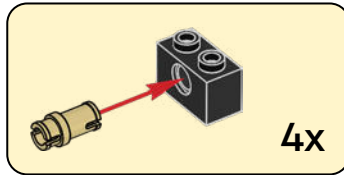

3

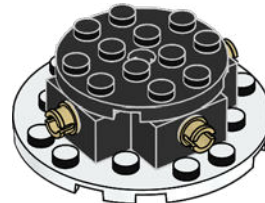

2

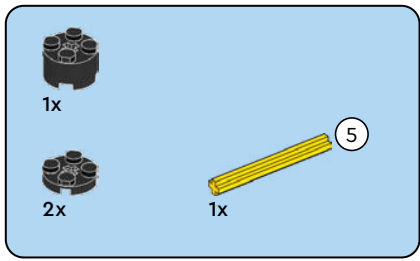

4

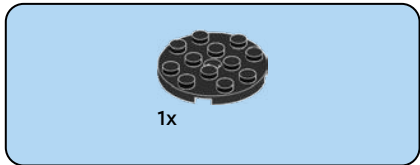
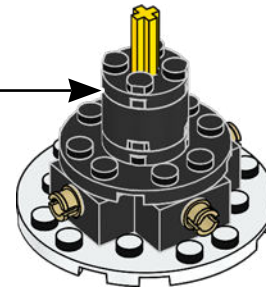
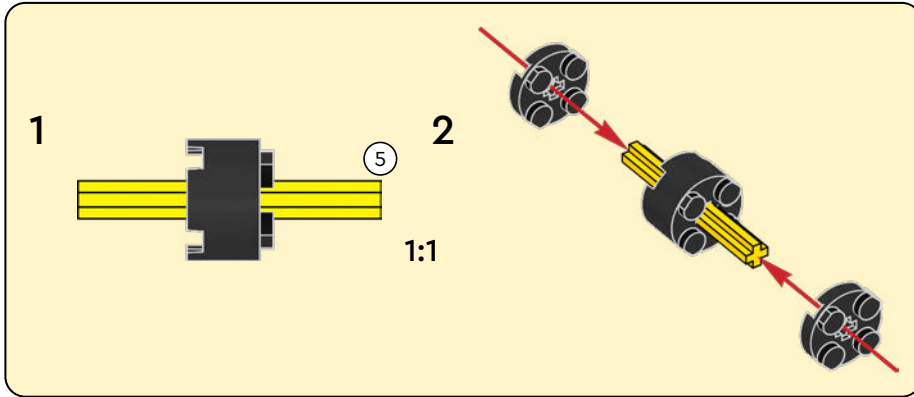

5





1x

6



4x



4x

7

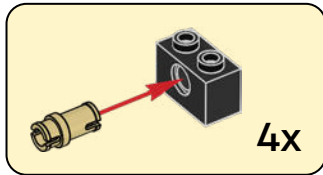

4x

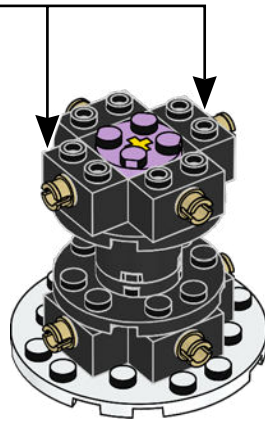

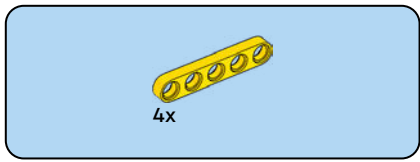

8

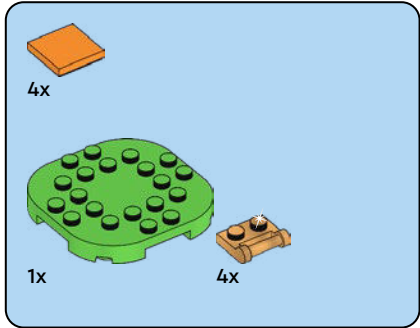
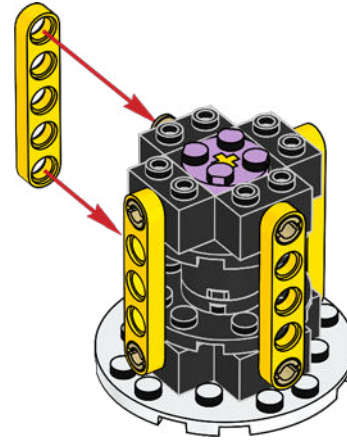

9

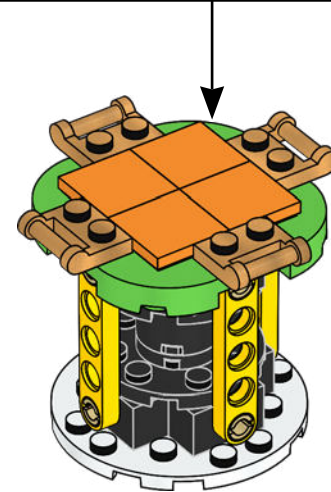
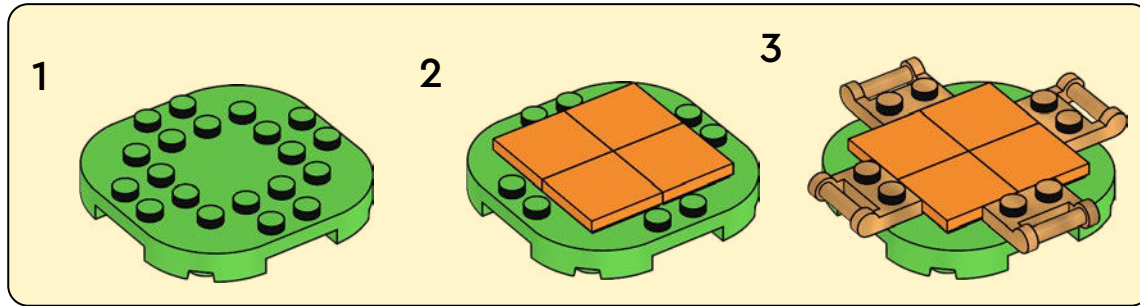

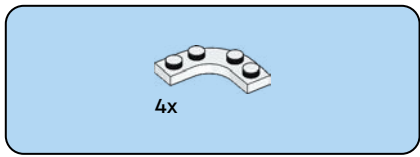

10

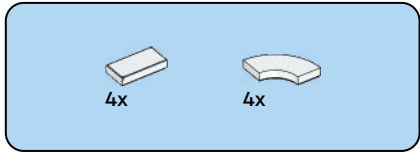
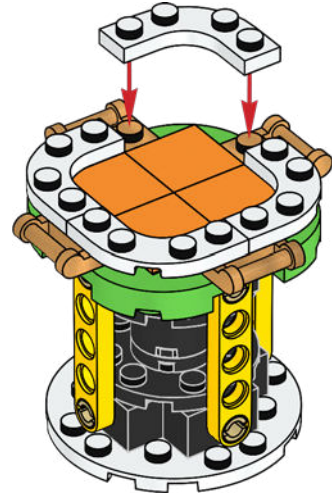

11

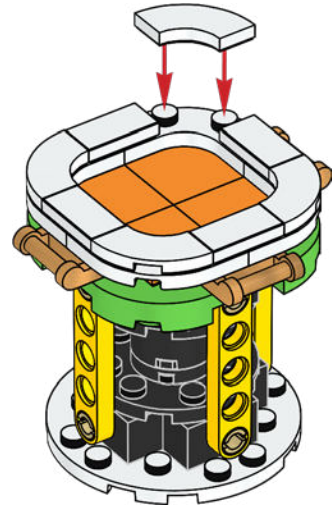

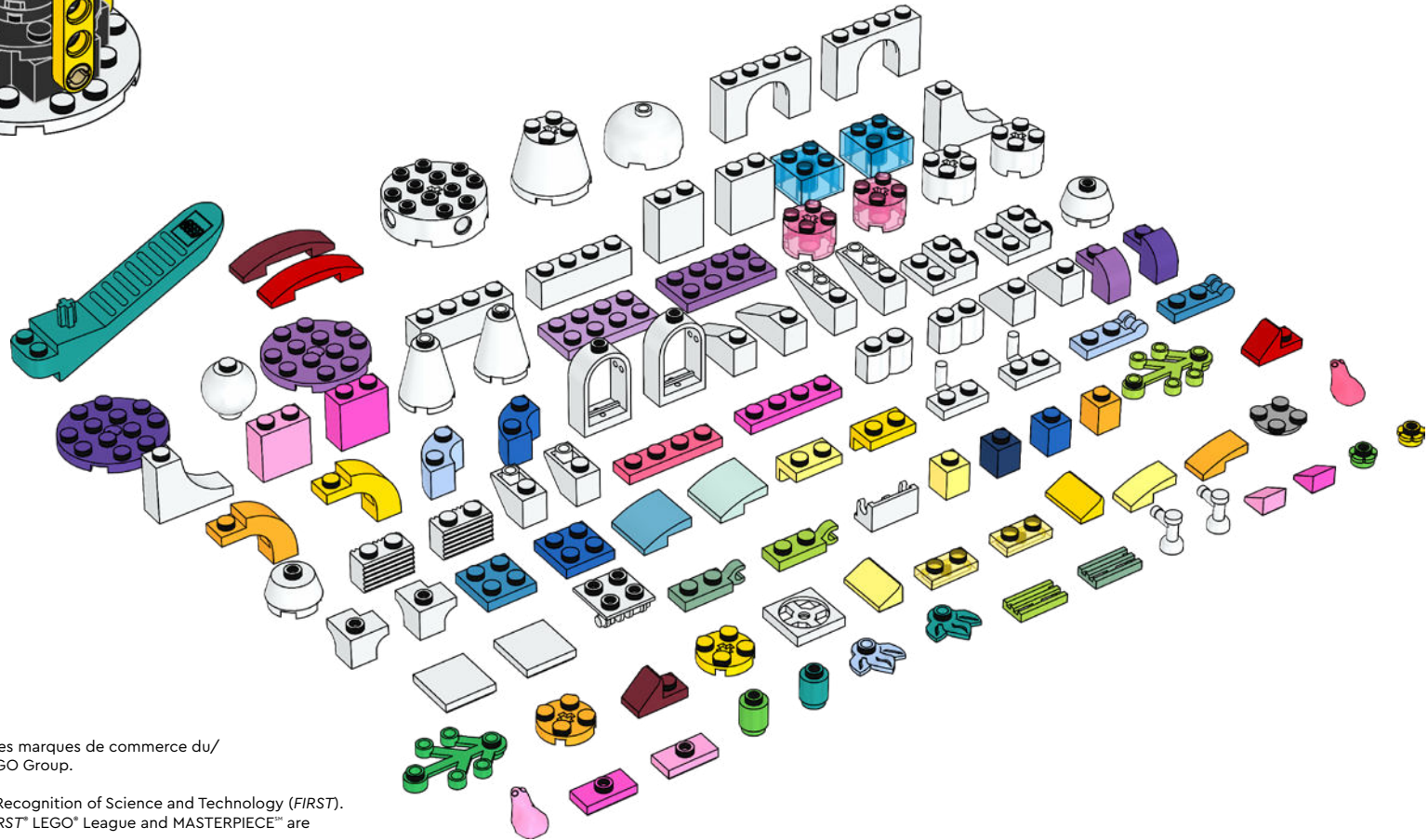
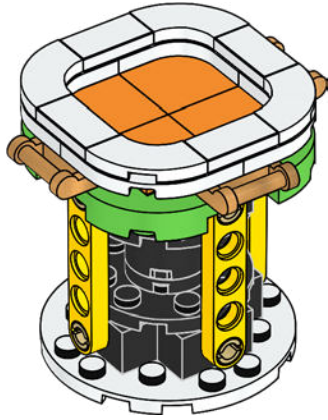

LEGO and the LEGO logo are trademarks of the/son des marques de commerce du/son marcas registradas de LEGO Group. ©2023 The LEGO Group.

FIRST® is a registered trademark of For Inspiration and Recognition of Science and Technology (FIRST).
LEGO® is a registered trademark of the LEGO Group. FIRST™ LEGO® League and MASTERPIECE™ are jointly held trademarks of FIRST and the LEGO Group.
©2023 FIRST and the LEGO Group. All rights reserved.