

FIRST® LEGO® League 2018 Pre-Pack Overview



Bat



Inspection Drone



Support Axles

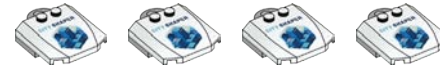

Coach Pins

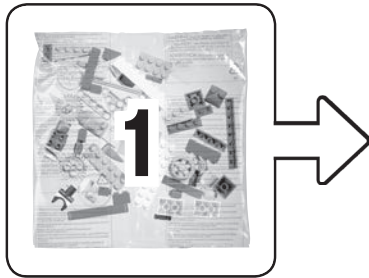

Precision Tokens

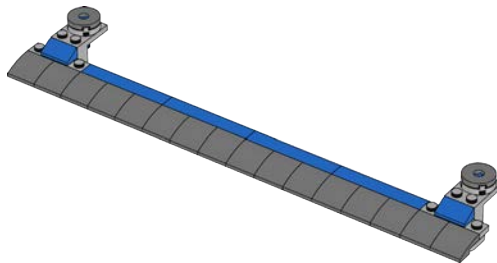

Bridge Entrance

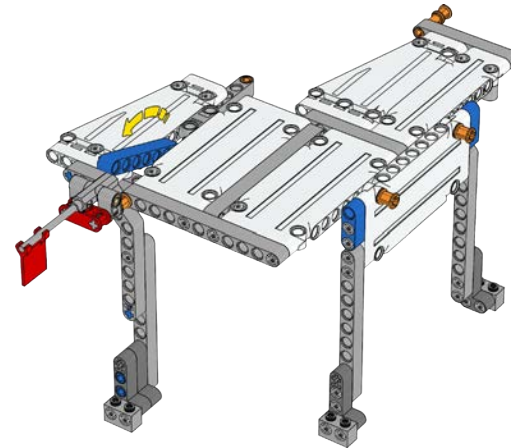

Bridge Top

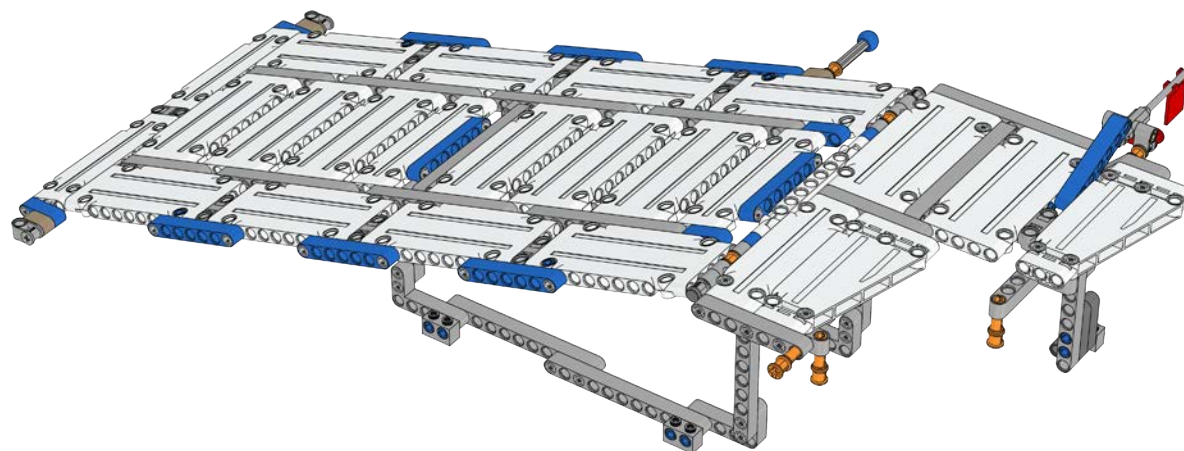
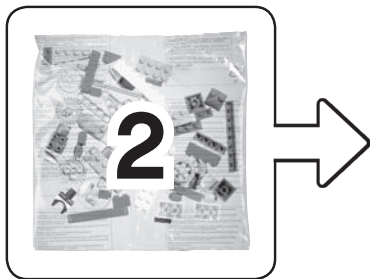

Bridge Ramp

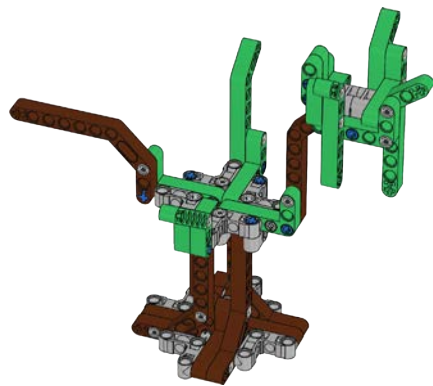
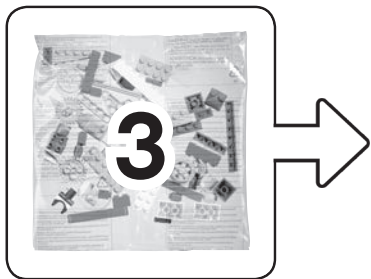

Tree

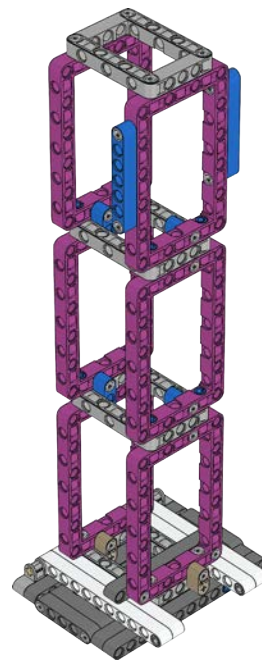

Steel Structure

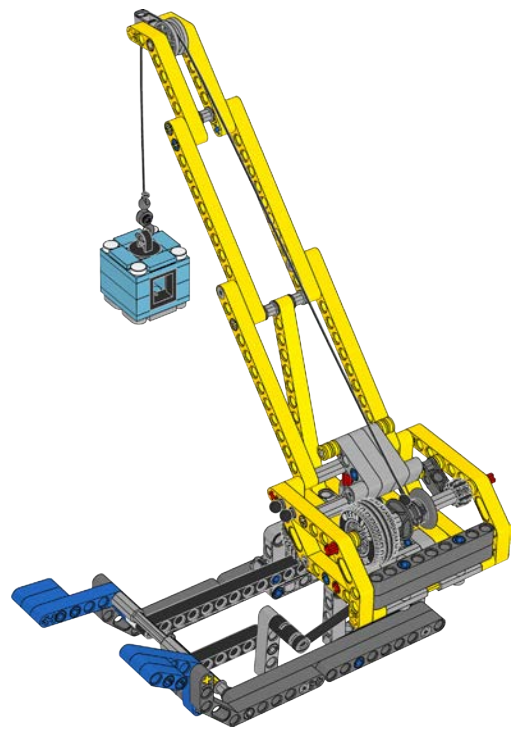
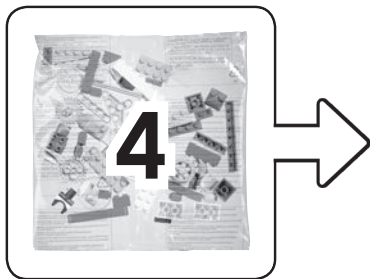

Crane

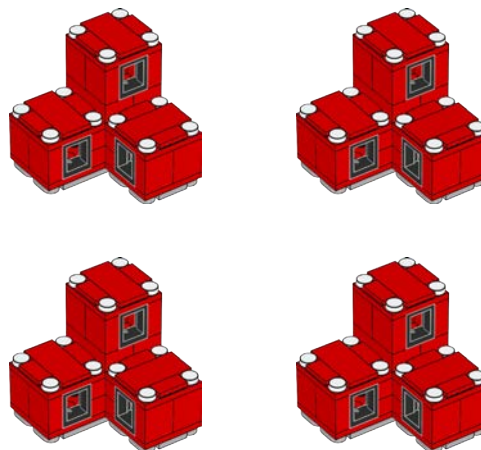
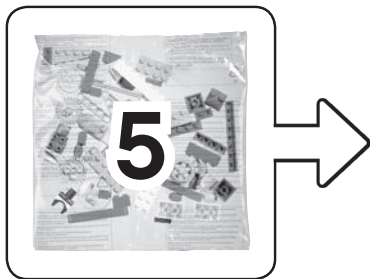

Red Building Units

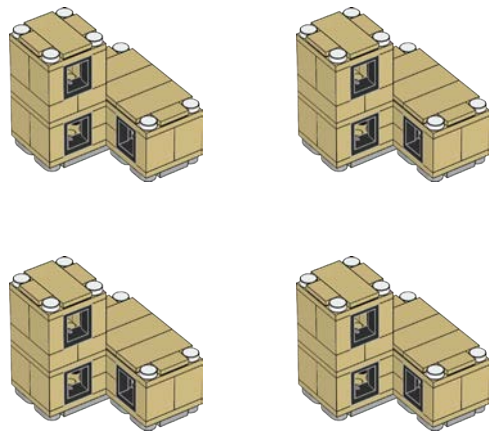
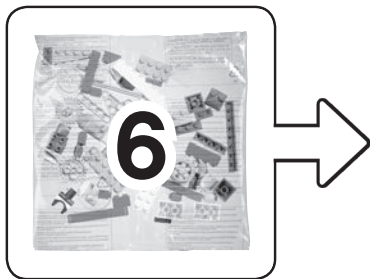

Tan Building Units

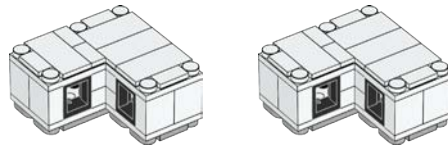
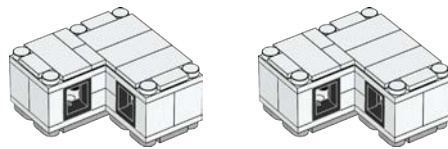
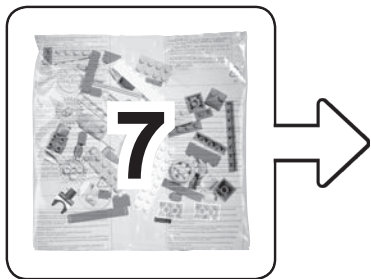

White Building Units

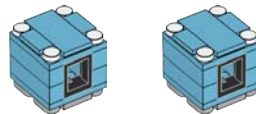
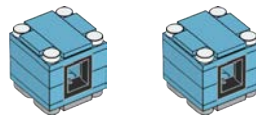

Blue Building Units



Building Upgrades

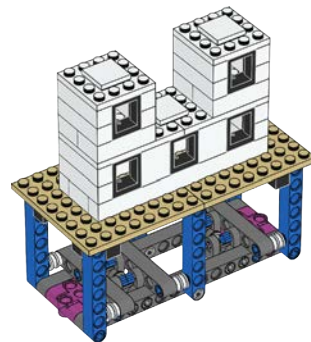
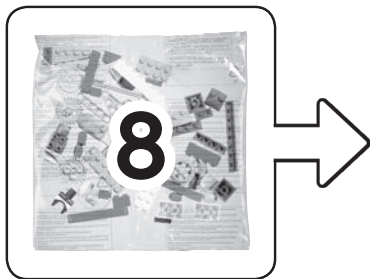

Test Building

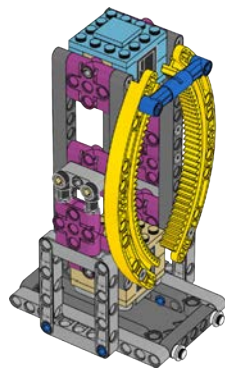

Elevator

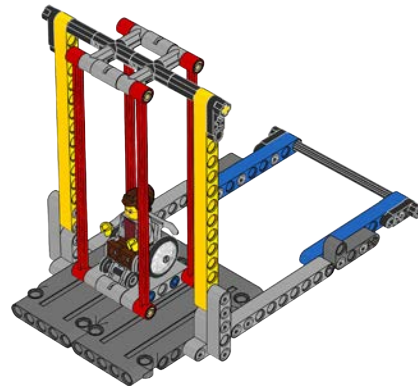
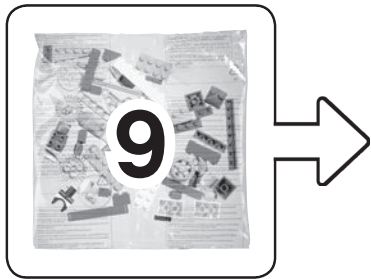

Swing

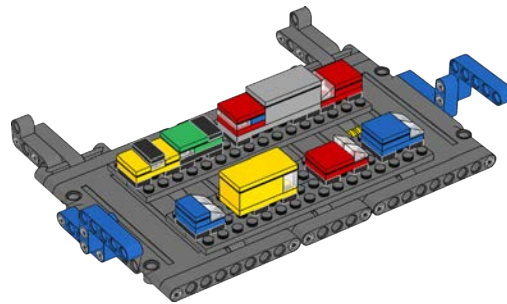

Traffic Jam

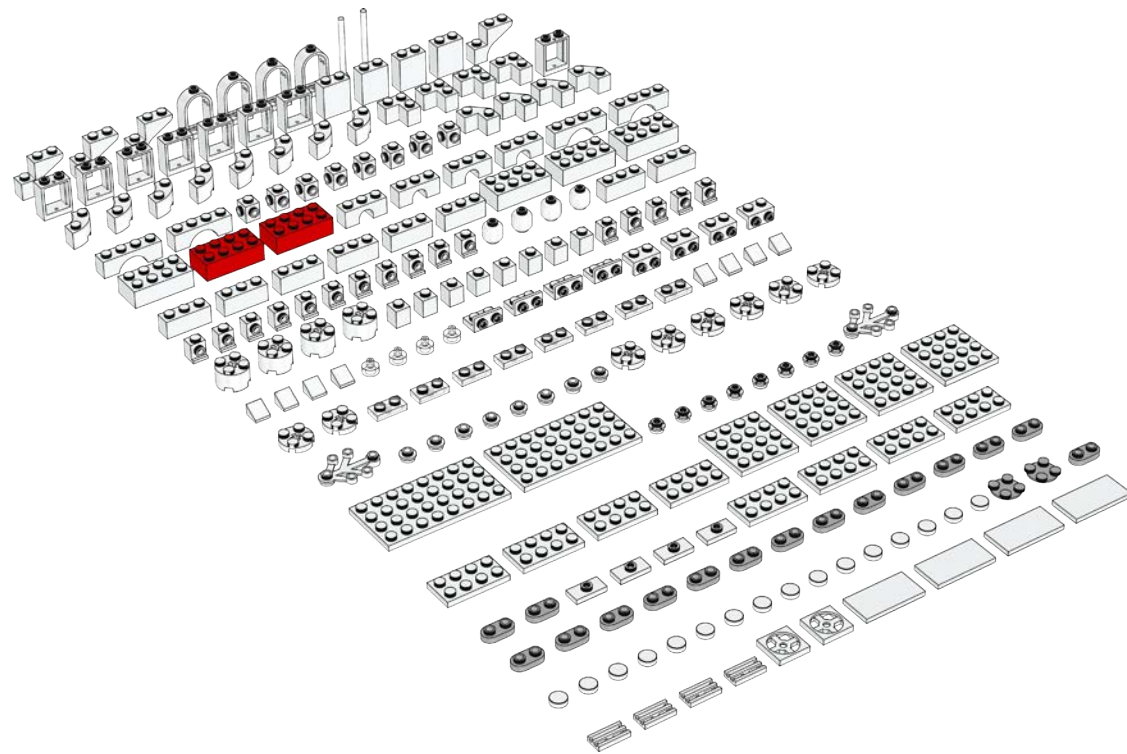
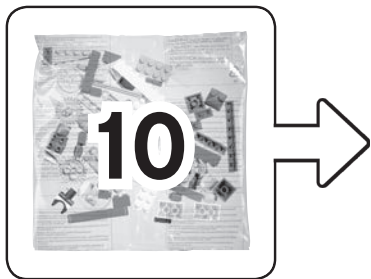

Innovation Elements

LEGO and the LEGO logo are trademarks of the/son des marques de commerce de/son marcas registradas de LEGO Group. ©2019 The LEGO Group.

The *FIRST*® logo is a registered trademark of the/Le *FIRST*® logo est une marquee depose de/El logotipo de *FIRST*® es una marca comercial registrada U.S. Foundation For Inspiration and Recognition of Science and Technology.